

Technical Specification

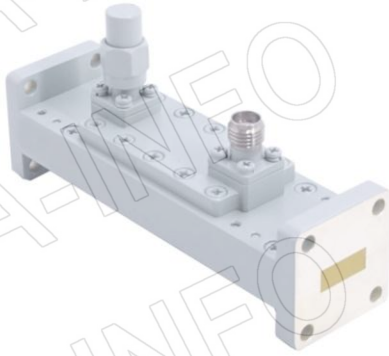

EIA WR	WR42
Frequency Range(GHz)	18.0 - 26.5
Coupling(dB)	40
Directivity(dB)	15 Typ.
Insertion Loss(dB)	0.1 Max. (Not including the theoretical loss 4.34×10^{-4} dB)
Mainline VSWR	1.15:1 Max.
Secondline VSWR	1.70:1 Max.
Flange	FBP220(UBR220)
Coupling Port	SMA-Female/ SMA-Male
Material	Cu
Size(mm)	76.2 x 22.4 x 39.7
Net Weight(Kg)	0.14 Around

Outline Drawing (Size: mm)

Coupling Port: SMA-Female

For SMA-Male connector Coupling Port outline drawing, please contact A-INFO.

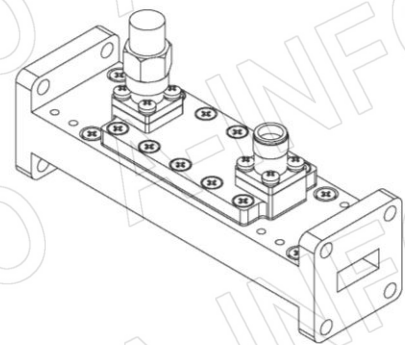
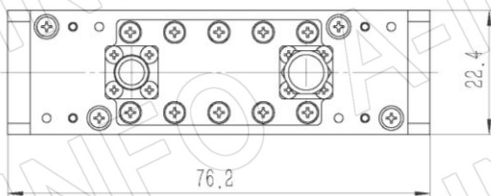
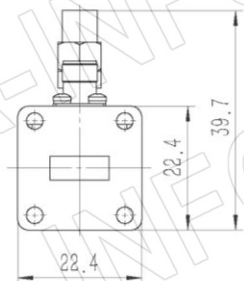
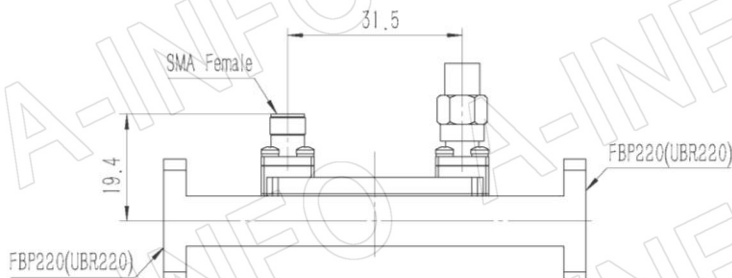

AINFO Inc.

Page 1 of 5

China(Beijing): Tel: (+86) 10-6266-7326,
China(Chengdu): Tel: (+86) 28-8519-2786,
USA: Tel: (+1) 949-639-9688,

(+86) 10-6266-7327 Fax: (+86) 10-6266-7379
(+86) 28-8519-3044 Fax: (+86) 28-8519-3068
(+1) 949-639-9608 Fax: (+1) 949-639-9670

Website: www.ainfoinc.com
Email: sales@ainfoinc.com

Flange Drawing (Size: mm)

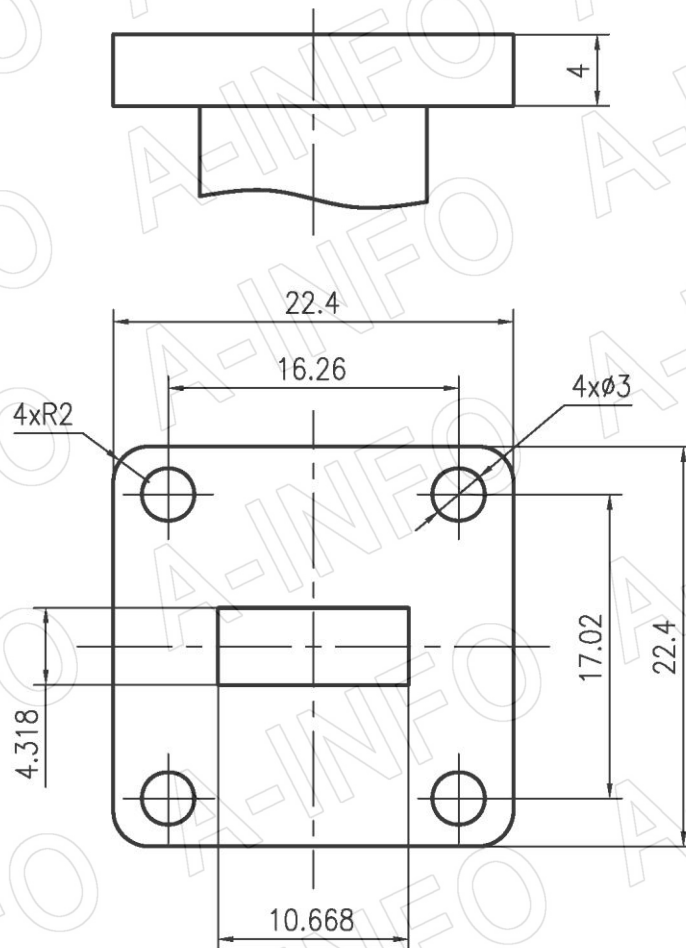

FBP220

AINFO Inc.

Page 2 of 5

China(Beijing): Tel: (+86) 10-6266-7326,
China(Chengdu): Tel: (+86) 28-8519-2786,
USA: Tel: (+1) 949-639-9688,

(+86) 10-6266-7327 Fax: (+86) 10-6266-7379
(+86) 28-8519-3044 Fax: (+86) 28-8519-3068
(+1) 949-639-9608 Fax: (+1) 949-639-9670

Website: www.ainfoinc.com
Email: sales@ainfoinc.com

Test Results

Coupling

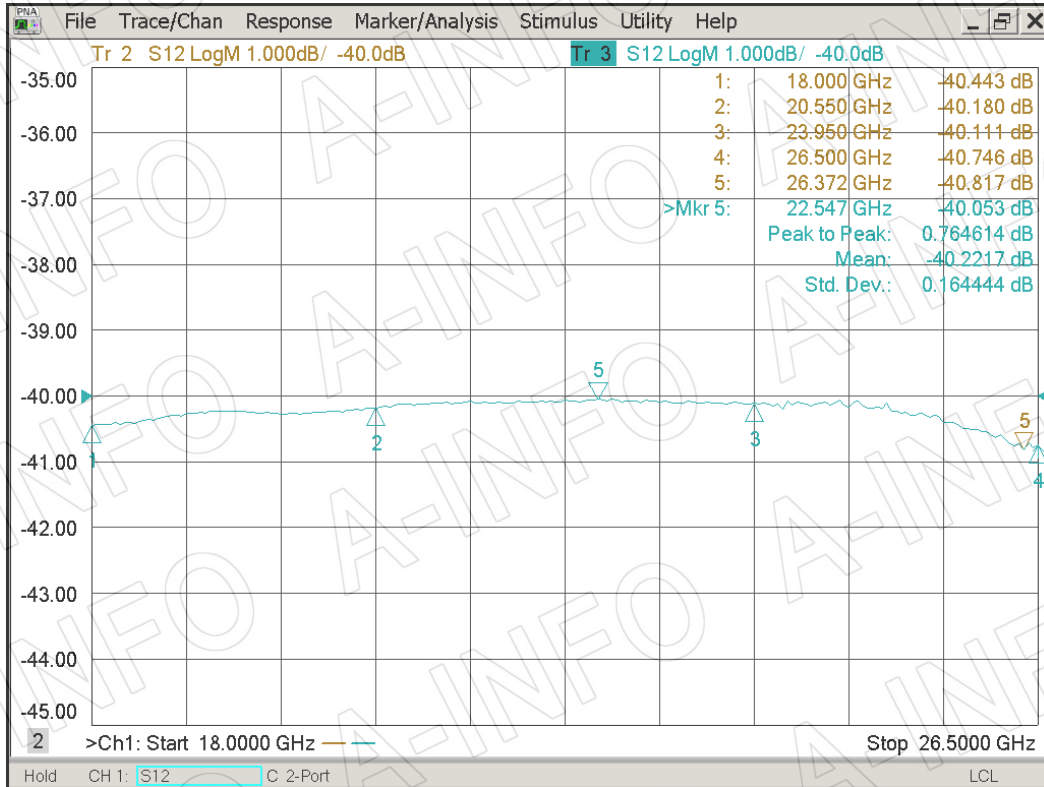

Directivity

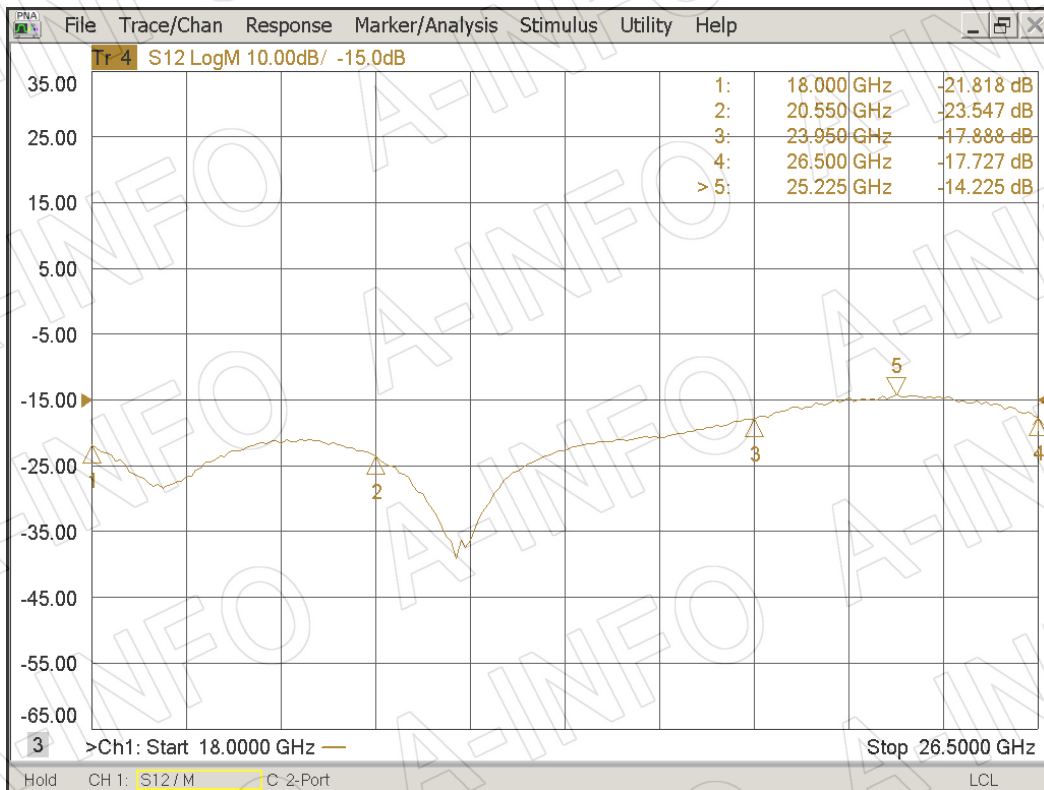

I.L. (including the theoretical loss 4.34×10^{-4} dB)

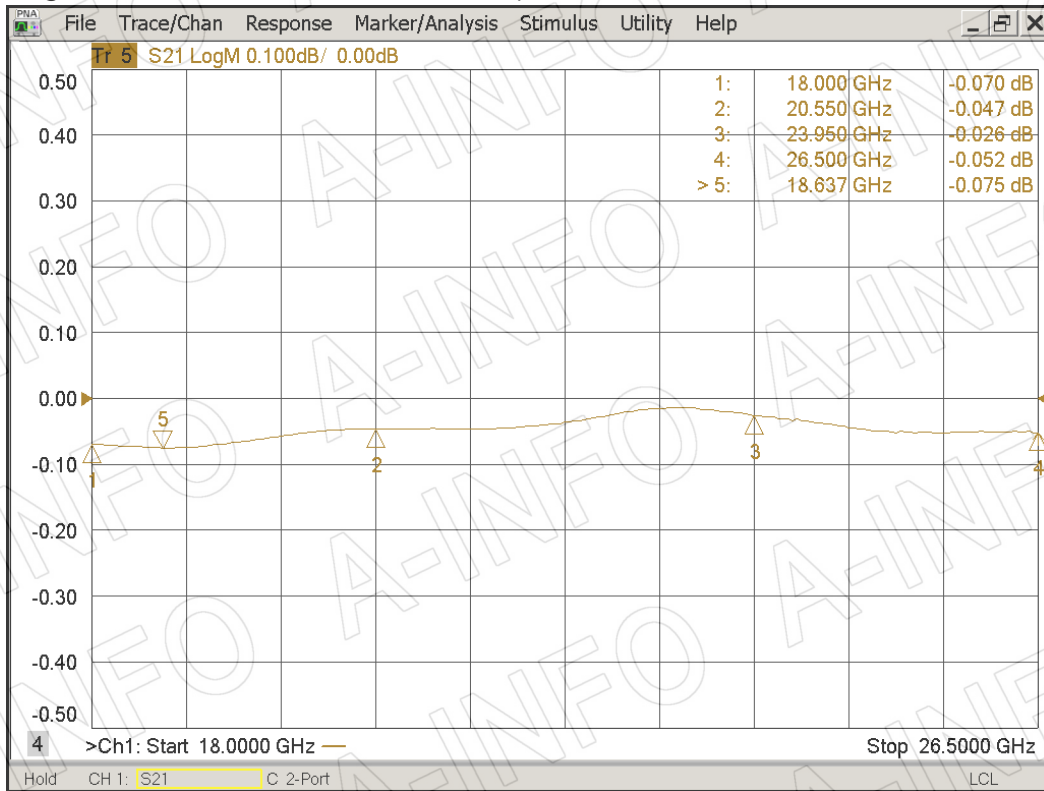

Mainline VSWR

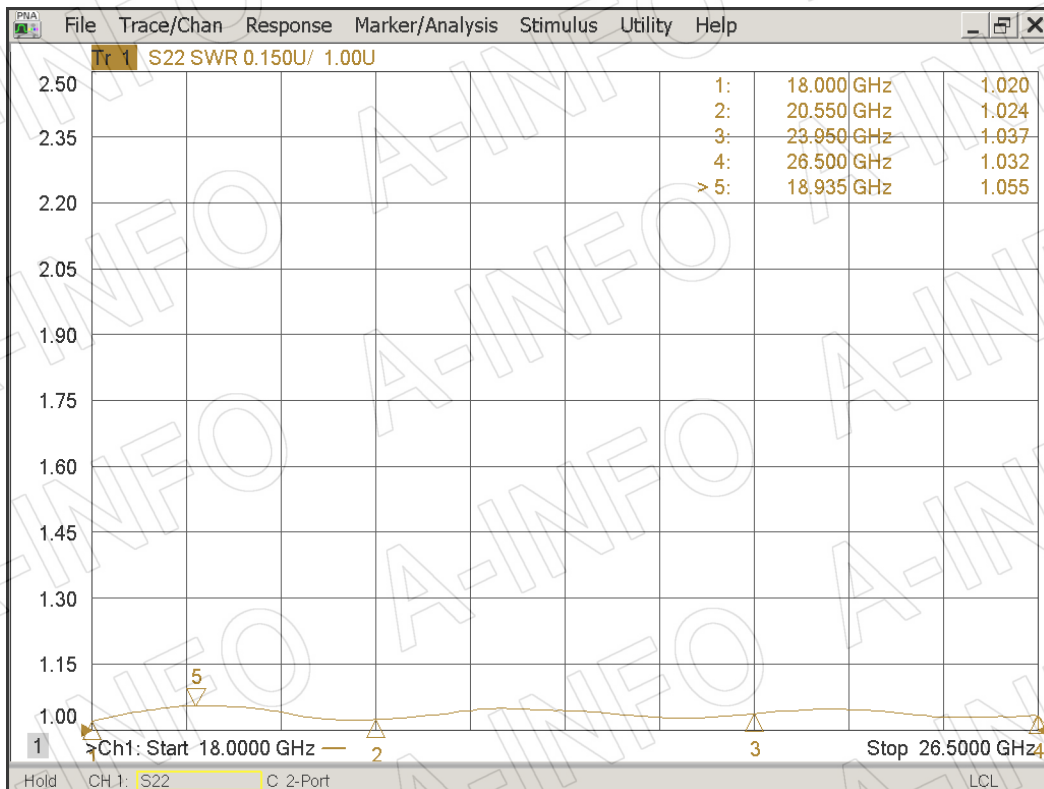

Secondline VSWR

